

# Application Research on Hydraulic Coke Cutting Monitoring System Based on Optical Fiber Sensing Technology

Dong ZHONG<sup>1,2</sup> and Xinglin TONG<sup>1\*</sup>

<sup>1</sup>Key Laboratory of Fiber Optic Sensing Technology and Information Processing, Wuhan University of Technology, Wuhan, 430070, China

<sup>2</sup>Department of Electronic and Information, Hubei University of Science and Technology, Xianning, 437100, China

\*Corresponding author: Xinglin TONG E-mail: zhongdong0129@163.com

**Abstract:** With the development of the optical fiber sensing technology, the acoustic emission sensor has become one of the focal research topics. On the basis of studying the traditional hydraulic coke cutting monitoring system, the optical fiber acoustic emission sensor has been applied in the hydraulic coke cutting monitoring system for the first time, researching the monitoring signal of the optical fiber acoustic emission sensor in the system. The actual test results show that using the acoustic emission sensor in the hydraulic coke cutting monitoring system can get the real-time and accurate hydraulic coke cutting state and the effective realization of hydraulic coke cutting automatic monitoring in the Wuhan Branch of Sinopec.

**Keywords:** Acoustic emission sensing, hydraulic coke cutting, monitoring system, signal

---

Citation: Dong ZHONG and Xinglin TONG, "Application Research on Hydraulic Coke Cutting Monitoring System Based on Optical Fiber Sensing Technology," *Photonic Sensors*, 2014, 4(2): 147–151.

---

## 1. Introduction

The hydraulic coke cutting monitoring system plays a very important role in the delayed coking unit. The basic principle of the hydraulic coke cutting system is that the high pressure water delivered from the high pressure water pump would pass through the water line, hose, and drill pipe to the hydraulic coke cutter nozzle, then spray out, forming the high pressure jet. The petroleum coke will be cut down by the impact of the high pressure water. The drill pipe would lift and rotate constantly until the coke is exhausted [1]. Currently, many petrochemical companies in our country are relying on the worker's related working experience to judge if the coke has been cleared in the coke tower. The timely and accurate judgment about the decoking

state by workers is vulnerable to the influence of various factors, thus improving the automation level of the hydraulic coke cutting monitoring system is imperative.

The optical fiber sensing technology is a kind of new technologies to research the relationship between the optical fiber and the external environment change. The optical fiber sensing technology is formed gradually accompanying with the development of the optical fiber and optical communication technology. The optical fiber sensing technology has become a very important part of modern information science. Light wave is the information carrier of the optical fiber sensor, and the optical fiber is the transmission medium for the optical fiber sensor, so the optical fiber sensing technology is a kind of new sensing technologies to

---

Received: 7 January 2014 / Revised version: 25 February 2014

©The Author(s) 2014. This article is published with open access at Springerlink.com

DOI: 10.1007/s13320-014-0180-5

Article type: Regular

provide the ability of perception and transmission outside. Because the optical fiber can be used as the light wave transmission medium, the characteristic parameters (amplitude, phase, polarization, wavelength, etc.) of the light wave in the fiber transmission will change caused by the factors (such as temperature, pressure, and magnetic field), and using and analyzing these changes can get certain properties of the outside role. So we can use the optic fiber as the sensor element to detect all kinds of physical and chemical quantity and biomass. This is the basic principle of the optical fiber sensor [2, 3]. The field experimental research shows that the acoustic emission sensor applied to the hydraulic decoking monitoring system can increase greatly the hydraulic decoking automation monitoring capability and can monitor the system state in real time and effectively in Wuhan branch of Sinopec.

## 2. Acoustic emission sensor and its application in the hydraulic coke cutting monitoring system

### 2.1 Basic principle of the acoustic emission sensor

The basic principle of the acoustic emission sensor is that the changes in outside conditions cause the changes in the cavity length of the Fabry-Perot (F-P) sensor, which leads to the F-P cavity reflection or the optical path difference change of the transmission interference beam. By using the photoelectric detector, we can detect interference light transmission or reflection signal changes to learn about the changes in the outside world, as shown in Fig. 1.

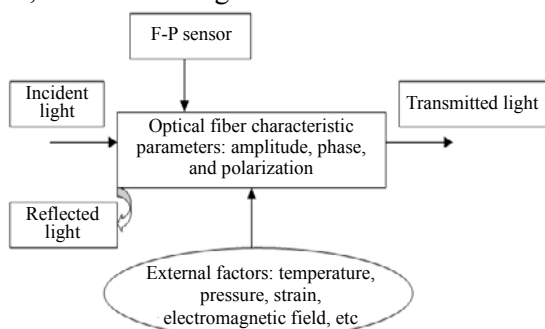

Fig. 1 Principle diagram of the acoustic emission sensor.

### 2.2 Application of the acoustic emission sensor system in the hydraulic coke cutting monitoring system

Acoustic emission is a phenomenon that the local energy is released quickly to emit the transient elastic wave. Acoustic emission often accompanies with the phenomenon of material deformation, fracture and fluid leakage, friction, impact, discharge and so on. The acoustic emission sensor system is to realize the real-time monitoring of the hydraulic coke cutting process by detecting, recording, and analyzing the defect or failure of the acoustic emission signal itself. Meanwhile, the system is to judge the hydraulic coke cutting state through the reasonable layout of the acoustic emission sensor [4–6]. In order to detect the acoustic emission signal of the hydraulic decoking process, we applied the following detection system. We designed the corresponding light source drive circuit, photoelectric conversion circuit, matching with the corresponding data acquisition card for data collection and built the following measurement system. We used this system to test the acoustic emission signal of the steel plate. The results show that the system can detect the corresponding acoustic emission signal, as shown in Fig. 2, which gives the monitoring principle block diagram of the acoustic emission sensor system. In experiments of Wuhan petrochemical, as shown in Fig. 3, the monitoring plan of the whole hydraulic coke cutting system is: there are 3 – 4 acoustic emission sensors installed through the tower in the coke layer direction. We could obtain the voice signal of the hydraulic coke cutting process, and the signal will be sent into the oscilloscope for analysis. At the same time, we used the data acquisition device to get the related collection data. We could judge the stage and state of hydraulic coke cutting through the acquisition of data and signal. Figure 4 shows the typical acquisition emission signal spectrum on the spot.

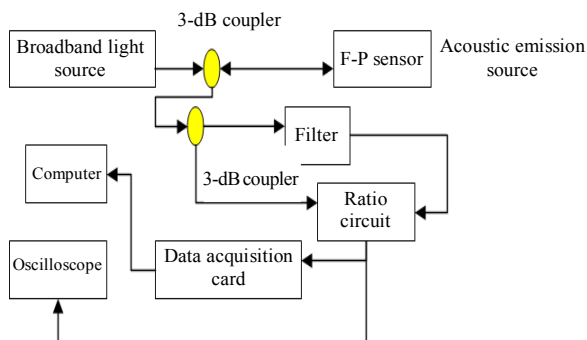

Fig. 2 Acoustic emission sensor monitoring system.



Fig. 3 Acoustic emission sensor of Wuhan petrochemical coke tower experimental installation.

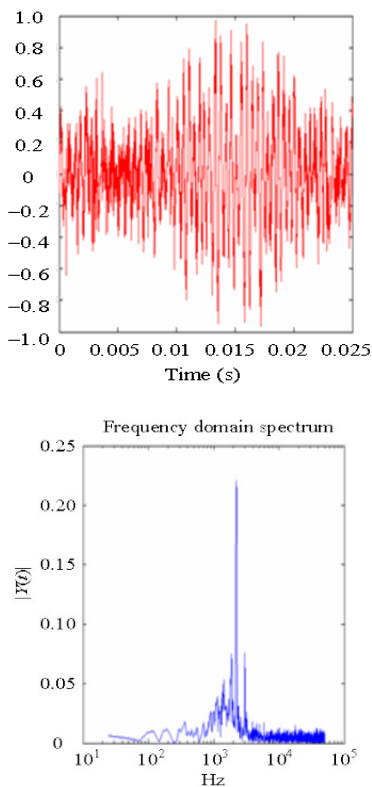

Fig. 4 Acquisition signal spectrum.

### 3.Acquisition data analysis of hydraulic coke cutting monitoring system

We studied the collected data from the hydraulic coke cutting process through the acoustic emission sensor system. The working process of the water nozzle generally falls into several stages: decline, rise, fall again during the hydraulic decoking process [7, 8], which is the cycle until all coke has been cleaned. In order to facilitate the analysis of the collected data, we can accord the water nozzle operation characteristics and the water nozzle entering into the coke to analysis two kinds of situations and then write a program in MATLAB to process data though fast Fourier transform (FFT) [9, 10]. We can research the rules of the water nozzle entering into the coke layer though a comparative analysis for these graphics.

(1) According to the operation characteristics of the bit, we selected more adjacent bit cutting coke stroke data of the acoustic emission sensor collected to analysis (drill down-up-down more stroke), and the whole signal spectrum analysis for several different cutting focal distances has been shown in Fig. 5.

In Fig. 5, 0927–0932 indicates the record period (09:27–09:32) in the Wuhan petrochemical field, and it is a cutting coke trip. 1027–1032, 1037–1043, and 1105–1109 indicate the periods of cutting coke strokes. Through the adjacent cutting coke stroke signal spectrum – frequency chart analysis of the acoustic signal, we could see that the voice signal frequency concentrated in about 220 Hz on every stroke, so we could judge the basic state of cutting coke through the voice signal frequency analysis and also the coke cutting stroke. We may draw a conclusion that the acoustic sensor could detect the decoking trip and judge the state of cutting coke. So we could guide the production effectively and achieve decoking automation.

(2) According to the state of the bit entering into the coke for analysis, considering FFT transformation is the average of the time period,

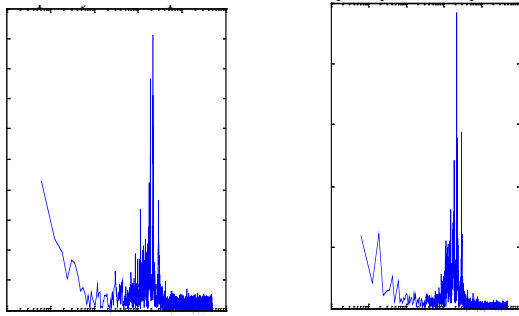

(a) 0927–0932  $f_{\max}=220.947$  (b) 1027–1032  $f_{\max}=218.956$

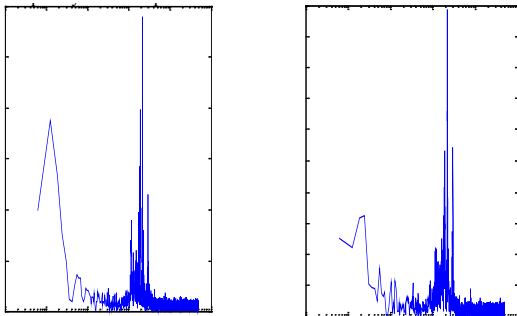

(c) 1037–1043  $f_{\max}=220.95$  (d) 1105–1109  $f_{\max}=221.936$

Fig. 5 Acoustic signal spectrum overall analysis of four typical cutting coke strokes.

from the record of the case, when the water nozzle runs in the process from the top of metal furnace wall to the coke of the furnace wall, the general location for the water nozzle in the cutting coke stroke could be identified clearly. Therefore, we may cut the cutting coke stroke into three stages, including water nozzle arriving at the surface of metal furnace wall, just entering from the furnace wall to the coke, and completely entering into the coke. The acoustic signal data of each stage were divided into two parts for analysis. The results of FFT analysis were more accurate than the former analysis. For one of the cutting coke schedules, for example, the water nozzle was operated at the top of the coke oven (after a decoking trip ended) when the time was 09:27, it was metal wall where no coke, which was also the travel start time. The water nozzle began to decline from 16.9 meters to 27 meters (the time was 09:32) when it began to rise. By 16.9 meters, the water mouth began to decline

until reaching the location of 18 meters, then the water nozzle entered into the coke layer. We can get the conclusion that the time of the water nozzle decline was about 30 seconds and the decline distance was about 1 m, the water nozzle entered into the coke layer, the data before entering into the coke should be the data before 30 seconds, then the data before 15 seconds should be the data of cutting coke water directly impacting on the metal wall state – A. We know that the time for the decline process in a decoking trip was about 180 seconds, the time before the water nozzle entered into the coke was about 30 seconds, and the 150 seconds left were divided into three time periods – B, C, and D. The three kinds of statuses could be divided into three stages: the stage before the water nozzle entered into the coke layer, the stage of the part of the nozzle entering into the coke, and the stage of the nozzle completely entering into the coke. Then, through the analysis for these data of A, B, C, D states, we can get the acoustic sensor acquisition signal analysis chart in Fig. 6.

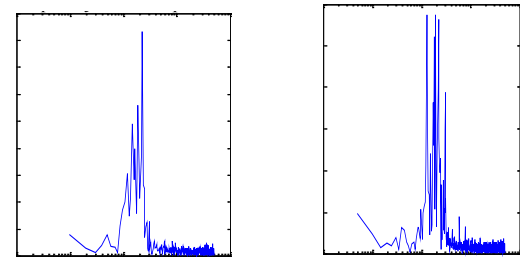

(a)  $f_{\max}=2.3024e+03$  (b)  $f_{\max}=1.9043e+03$

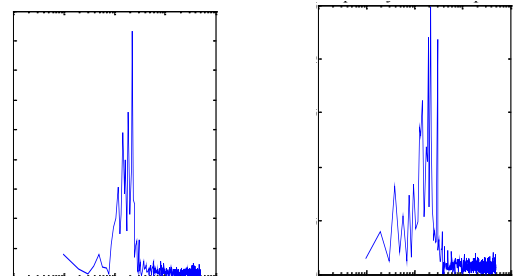

(c)  $f_{\max}=224.6094$  (d)  $f_{\max}=114.8438$

Fig. 6 Diagram of the acoustic signal analysis of the exact location.

According to the acoustic signal analysis of the

exact location for the tap and coke cutting process, we can draw the following conclusions:

(1) The acoustic signal frequency is relatively high before the water nozzle enters into coke, generally about 2000Hz; the frequency is low when the bit enters completely into the coke, only about 100Hz.

(2) The acoustic sensor can distinguish clearly the location of the drill bit, and at the same time, it can determine the decoking degree and also can judge the drill stroke.

(3) The acoustic signal sensor can detect the low frequency signal, and it is also able to detect the high frequency signal.

#### 4. Conclusions

The F-P acoustic emission sensor can measure both high frequency and low frequency signals. The experimental results showed that the sensor could be used for on-line monitoring of the progress of hydraulic coke cutting. By using the F-P acoustic sensor to judge the coke cutting nozzle location in the decoking process and control the travel time, combined with the experience of the manual operation method, we can develop a corresponding programmable logic controller (PLC) control program. We used the acoustic emission sensor applied to the hydraulic coke cutting monitoring system, and we found it can better achieve the real-time control of the coke cutting state and realize effectively the state monitoring automation of hydraulic coke cutting.

#### Acknowledgment

This work is supported by the National Natural Science Foundation of China (Grant No. 51275373)

and the Key Project of National Natural Science Foundation of China (Grant No.50830230); Hubei Province young teachers of college working into the enterprise project, number: XD2012363.

**Open Access** This article is distributed under the terms of the Creative Commons Attribution License which permits any use, distribution, and reproduction in any medium, provided the original author(s) and source are credited.

#### References

- [1] B. Lee, "Review of the present status of optical fiber sensors," *Optical Fiber Technology*, 2003, 9(2): 57–79.
- [2] L. H. Chen, C. C. Chan, W. Yuan, S. K. Goh, and J. Sun, "High performance chitosan diaphragm-based fiber-optic acoustic sensor," *Sensors and Actuators A: Physical*, 2010, 163(1): 42–47.
- [3] F. Li, "Hydraulic coke cutter displacement real-time monitoring system," M.S. thesis, School of Mechanical Engineering, Dalian University of Technology, 2003: 1–48.
- [4] T. Wang, Z. Gao, J. Ye, and X. Hu, "Hydraulic decoking detection system design and research," *Journal of Engineering Design*, 2012, 17(2): 146–150.
- [5] R. Zhang, "Wavelet analysis in the application," *Computer Simulation*, 2005, 22(8): 69–72.
- [6] S. Gongtian, G. Rongshen, and L. Wind, "Parameter analysis of acoustic emission signals," *Nondestructive Testing*, 2002, 24(2): 72–77.
- [7] W. Zuo, X. Wang, and G. Zhao, "Intelligent sensor design and information processing technology," *Technology Manufacturing Industry Design Technology*, 2000, 12(5): 38–43.
- [8] Y. Zhang, "The result of the measurement data processing," *Shanghai Measurement Test*, 2001, 47(4): 27–30.
- [9] B. A. L. Gwandu, X. W. Shu, and Y. Liu, "Simultaneous measurement of strain and curvature using superstructure fibre Bragg gratings," *Sensors and Actuators A: Physical*, 2002, 96(2): 133–139.
- [10] K. T. V. Grattan and T. Sun, "Fiber optic sensor technology: an overview," *Sensors and Actuators A: Physical*, 2000, 82(1–3): 40–61.