

Adaptive PMD compensation in 10-Gb/s RZ optical communication system

Xiaoguang Zhang (张晓光), Li Yu (于 丽), Guangtao Zhou (周光涛),
Yu Shen (沈 昱), Yuan Zheng (郑 远), Chaoyang Li (李朝阳),
Yumin Liu (刘玉敏), Lin Chen (陈 林), and Bojun Yang (杨伯君)

Department of Physics, School of Science, Beijing University of Posts and Telecommunications, Beijing 100876

Received February 10, 2003

We report an experiment of adaptive compensation for first-order polarization mode dispersion (PMD) in 10-Gb/s return zero (RZ) optical communication system. The compensated differential group delay (DGD) is up to 30 ps. The quasi-real-time, less than one second, PMD compensation is realized. In the experiment, for the first time, the algorithm so-called particle swarm optimization (PSO) is used to control feedback compensation system.

OCIS code: 060.2330.

Polarization mode dispersion (PMD) is one of the dominant obstacles in beyond 10-Gb/s optical communication systems. The adaptive PMD compensators are needed to be established to overcome this limitation. Several works^[1-4] of adaptive PMD compensation experiments have been reported. In our previous work, we have realized PMD compensation with manual techniques^[5]. In this paper, we report an experiment of adaptive first-order PMD compensation in 10-Gb/s return zero (RZ) optical communication system. It is, to our knowledge, the first experiment in China of automatic PMD compensation for 10-Gb/s RZ optical communication systems.

The first-order PMD is the differential group delay (DGD) between two principal states of polarization (PSP's)^[6]. In Poincaré sphere it can be represented by PMD vector $\vec{\Omega}$, where, $\hat{q} = \vec{\Omega}/\Delta\tau$ represents the fast axis direction of polarization state in Poincaré sphere, and $\Delta\tau = |\vec{\Omega}|$ represents the DGD between two PSP's. If $\vec{\Omega}_f$ is used to represent PMD vector of transmission fiber in optical communication system and $\vec{\Omega}_c$ is the PMD vector of compensator, the total PMD vector of system would be

$$\vec{\Omega}_{\text{total}} = \vec{\Omega}_f + \vec{\Omega}_c, \quad (1)$$

and the total DGD of whole system^[2] would be

$$\Delta\tau_{\text{total}} = |\vec{\Omega}_f + \vec{\Omega}_c| \\ = \sqrt{(\Delta\tau_f)^2 + (\Delta\tau_c)^2 + 2\Delta\tau_f\Delta\tau_c \cos(2\theta)}, \quad (2)$$

where $\Delta\tau_f = |\vec{\Omega}_f|$ and $\Delta\tau_c = |\vec{\Omega}_c|$ are DGDs induced by transmission fiber and compensator separately, 2θ is the angle between fast axes of PSP's in transmission fiber and PSP's in compensator on Poincaré sphere.

PMD compensator generally consists of a polarization controller and a variable time delay set, and aims at $\Delta\tau_{\text{total}} = 0$. Firstly, reach $\theta = 90^\circ$ to minimize $\Delta\tau_{\text{total}}$ by adjusting polarization controller. Secondly, adjust $\Delta\tau_c$ of variable time delay set till $\Delta\tau_{\text{total}} = 0$.

Adaptive PMD compensator consists of three parts as shown in Fig. 1. PMD compensation unit is used to

compensate PMD of optical system. PMD monitor unit is used to monitor the changes of PMD in transmission system and feed them to logical control unit. According to the PMD monitoring signal and logical calculation, the logical control unit adjusts the magnitude of compensation by controlling PMD compensation unit and reaches the goal of adaptive PMD compensation for optical communication system.

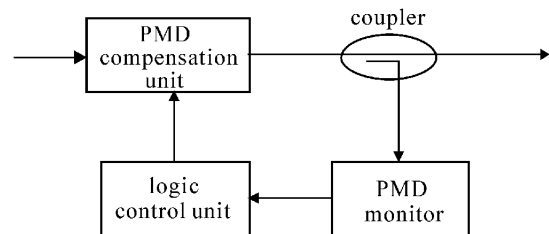

Fig. 1. The basic structure of adaptive PMD compensator.

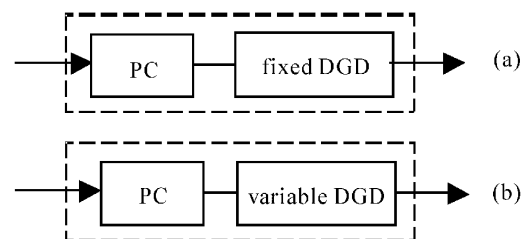

Fig. 2. Two structures for first-order PMD compensators. (a) DGD fixed; (b) DGD variable.

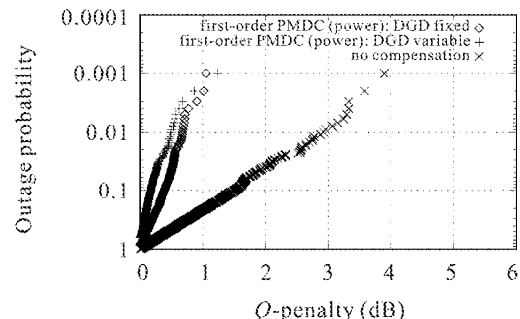

Fig. 3. The comparison of compensation effects using fixed DGD and variable DGD in first-order PMD compensator.

There are generally two structures for first-order PMD compensators, as shown in Fig. 2. One consists of a polarization controller (two or three degrees of freedom (DOF)) and a fixed DGD time delay set. The other consists of a polarization controller (two or three DOFs) and a variable DGD time delay set (one DOF).

We made the comparison between above two compensators according to their compensation effects to first-order PMD by numerical simulation as shown in Fig. 3. In Fig. 3, X -coordinate is Q -penalty and Y -coordinate is outage probability. The result of simulation shows that: 1) Q -penalty of system after compensation falls greatly, receding from 4 dB to below 1.4 dB; 2) DGD variable compensation mode is better than DGD fixed compensation mode. But if the value of fixed DGD is chosen appropriately, DGD variable compensation mode only improves the performance slightly, but in comparison with fixed DGD compensation mode, it has more complex compensation control comparing with (more DOFs to control). Considering compensation performance and complexity synthetically, our experiment adopts fixed DGD compensation structure to reduce the DOFs.

There are two methods to monitor PMD signal in fiber link, one is to monitor degree of polarization (DOP) and the other is to monitor power of specific frequency component in electrical domain. The process of the latter is to convert optical signal to electrical signal using photodetector, then to the sampling power of specific frequency component by using band-pass filter. Because of simple configuration and low cost, we adopt the latter method.

Theoretically, the electrical power of specific frequency component after band-pass filter is^[3]

$$P(f) \propto 1 - 4\gamma(1 - \gamma) \sin^2(\pi f \Delta\tau_{\text{total}}), \quad (3)$$

where γ and $1 - \gamma$ are power fractions in two directions of input PSP's, $\Delta\tau_{\text{total}}$ is the DGD between output PSP's after transmission. Figure 4 illustrates the relations of electrical power of 10 and 5 GHz to DGD in fiber link, respectively. Figure 4(a) shows the theoretical result according to Eq. (3), and Fig. 4(b) shows the experimental result in which the vertical axis is normalized power to the case without PMD. In our experiment, we use 5-GHz band-pass filter because of its fast change curve.

The detailed procedure of obtaining feedback signals is as follows. The optical signal power is detected through photodetector, and the power of specific frequency component is extracted from band-pass filter. Then it is converted into voltage signal, and collected by computer through data acquisition card for control. Because voltage signal is comparatively small, a signal-trimming module is added to amplify signal with noise suppression before signal is sent into data acquisition card. This has the advantage of powerful capacity of noise resistance.

In logic control unit, an artificial intelligence search algorithm, called particle swarm optimization (PSO), is adopted to control feedback compensation system. The advantages of the PSO algorithm are: powerful capacity of global search which will not sink in partial maximum (corresponding to sub-optimum); powerful capacity of noise resistance which fits for low signal-noise ratio (SNR) system; suitable for multi-DOF system with fewer parameters to be modified and rapid searching

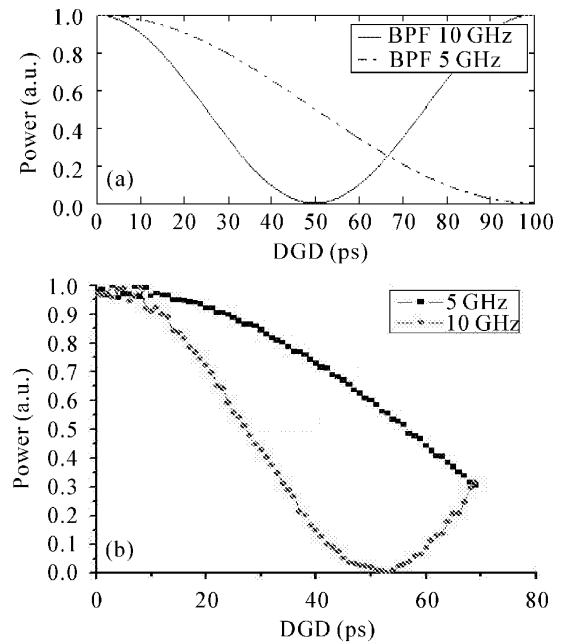

Fig. 4. The relation of 5- and 10-GHz power to DGD ($\gamma = 0.5$). (a) Theoretical and (b) experimental results.

speed. Therefore, PSO algorithm is most effective for PMD compensation.

The experiment setup for the adaptive PMD compensation is shown in Fig. 5. In the experiment, the RZ sequence pulses are produced by an actively mode-locked fiber ring laser^[7], in which the key components are semiconductor optical amplifier (SOA) and electro-absorption (EA) modulator which make it more stable than that made by erbium-doped fiber amplifier (EDFA) and Mach-Zehnder modulator. $2^{23} - 1$ pseudo-random RZ pulse sequence is produced by a 10-GHz Mach-Zehnder modulator (Corning Co., OTI MOD-N-10S). Signals that have been amplified by EDFA are sent into PMD emulator. The PMD emulator consists of a polarization controller and a section of polarization maintaining fiber #1. The DGD of emulator is 0 – 29 ps measured by Sagnac interferometer^[8]. The compensator adopts fixed DGD mode as shown in Fig. 5, where PC-410 (Corning Co.) with 4 electro-optic plates to be controlled is used as polarization controller controlled by 0–4-V voltage. The feedback signal controls three plates of them, working as quarter-wave plate, half-wave plate and quarter-wave plate, respectively. Fixed DGD of the compensator is 30 ps, produced by another section of polarization maintaining fiber #2. A 50:50 coupler splits one channel signal to digital sampling oscilloscope (Tek 11801C) to show PMD compensation effect and the other channel signal to PMD monitor. The output signal of photodetector (bandwidth 20 GHz) passes 5-GHz band-pass filter to extract specific frequency signal. It is converted into voltage signal by microwave detector and sent into logic control unit. The logic control unit and the feedback algorithm we use have the advantages of powerful capacity of noise resistance, powerful capacity of global searching and rapid speed for compensation, as discussed above.

In the experiment, the oscilloscope is used to show the

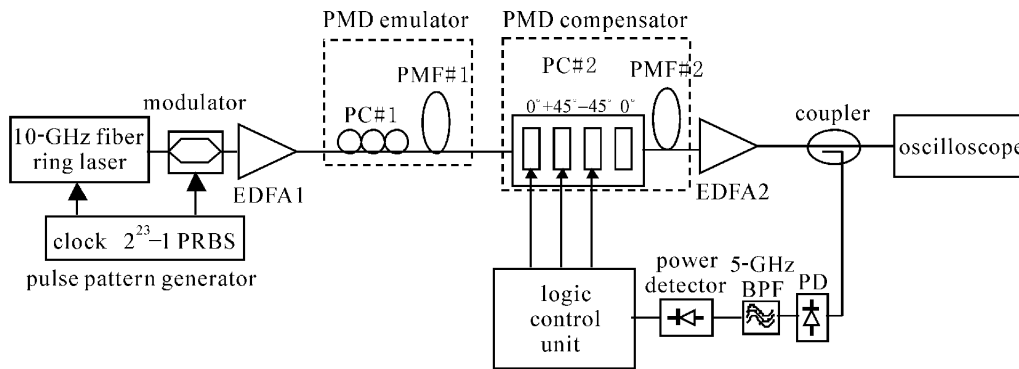

Fig. 5. Experiment setup. PRBS: pseudo-random bit sequence; EDFA: erbium-doped fiber amplifier; PC: polarization controller; PMF: polarization maintaining fiber; PD: photodetector; BPF: band-pass filter.

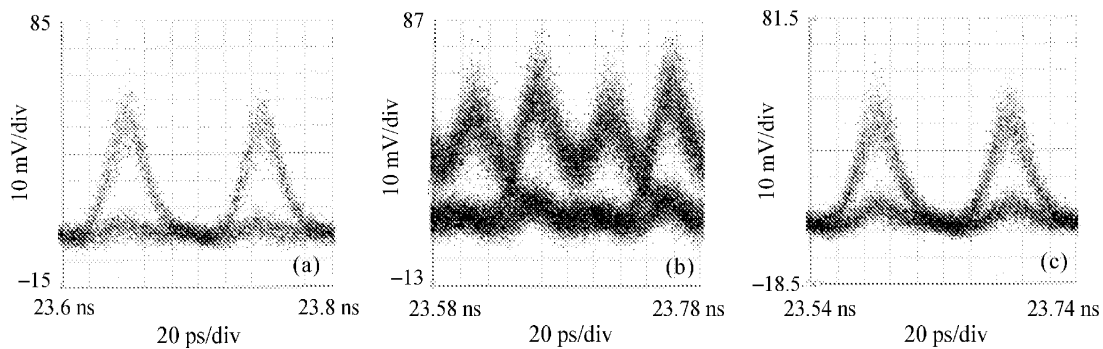

Fig. 6. Eye diagrams to show the procedure of adaptive PMD compensation. (a) Back-to back; (b) without PMD compensation; (c) with PMD compensation.

whole procedure of adaptive PMD compensation (Fig. 6). Figure 6(a) shows the eye diagram of back-to-back signals. Figure 6(b) shows the eye diagram without PMD compensation. Figure 6(c) shows the eye diagram with PMD compensation. On the screen of the oscilloscope, the whole time of procedure from starting compensation to stable situation (Fig. 6(c)) is estimated to be less than 1 s with human eye, which means that the sampling and feedback system has rapid searching speed. If the polarization controller in PMD emulator is changed at random, system will turn back to the state as Fig. 6(c) in less than 1 s, which means the adaptive PMD compensation is realized.

The response time of the compensator depends on the strategy of the chosen algorithms and the performance of the hardware including A/D, D/A, voltage-controlled polarization controller, etc. It is not the real response time for compensation that is seen on the oscilloscope. Defining the time slot from the previous D/A to the next D/A as one time unit, which can be used to measure the response time of the compensator. In PMD compensation loop, many events happened in one time unit: 1) D/A converter writing a voltage to the voltage-controlled PC, 2) waiting PC reaching its steady state, 3) A/D conversion, 4) processing the data in the processor with PSO algorithm. Then the next D/A conversion begins. The sampling rates of A/D and D/A converter used in the experiment are both 100 kHz. We measured 420 time units by reading the timer in the processor. The total averaged time is 380 ms for 420 time units. Thus one

time unit is equivalent to about 0.9 ms.

In order to determine the time used for whole compensation procedure, we set following experiment of recording the electrical powers using 5-GHz band-pass filter in searching process. In PSO algorithm, 20 particles are employed. The time used for one particle treatment includes all the events mentioned above. So one iteration (containing 20 particles treatment) for searching is equivalent to 20 time units (less than 20 ms). For this time testing experiment, the maximum iteration number is set to 50. We repeated the experiment 50 times, and got the results shown in Fig. 7. In Fig. 7, the distribution of electric powers in each iteration for

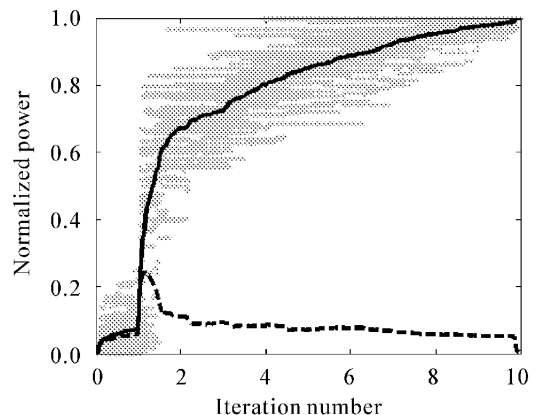

Fig. 7. The distribution of electric powers versus iteration number for 50 experiments.

50 experiments is marked with gray area. The solid line is the average result and the dashed line denotes the standard deviation. It is shown that it needs averagely 4 iterations for the normalized electric power to reach 0.8. With 10 iterations (equivalent to less than 200 ms), searching optimization is nearly completed, which means that the response time of our compensator is less than 200 ms.

We have made a successful experiment of adaptive first-order PMD compensation for 10-Gb/s RZ optical communication system. The compensated PMD value is up to 30 ps. Automatic searching time is less than 1 s. The quasi-real-time adaptive PMD compensation is realized. In the experiment, for the first time, the algorithm so-called PSO is used to control feedback compensation system, which is proved to be powerful searching capacity.

The authors would express their acknowledgment to Professor Minyu Yao of Department of Electronic Engineering, Tsinghua University, for providing 10-GHz actively mode-locked fiber ring laser.

This work was supported by the National "863" High Technology Project of China (No. 2001AA122041), and the National Natural Science Foundation of

China (No. 60072042). X. Zhang's e-mail address is xgzhang@bupt.edu.cn.

References

1. T. Takahashi, T. Imai, and M. Aiki, *Electron. Lett.* **30**, 348 (1994).
2. F. Heismann, D. A. Fishman, and D. L. Wilson, in *Proceedings of ECOC'98* WdC11, 529 (1998).
3. H. Ooi, Y. Akiyama, and G. Ishikawa, in *Proceedings of OFC/IOOC'99* WE5-1, 21 (1999).
4. H. Y. Pua, K. Peddanarappagari, B. Y. Zhu, C. Allen, K. Demareat, and R. Q. Hui, *J. Lightwave Technol.* **18**, 832 (1999).
5. X. M. Liu, C. Y. Li, R. H. Li, B. J. Yang, and X. G. Zhang, *Semiconductor Optoelectron.* (in Chinese) **22**, 386 (2001).
6. C. D. Poole and D. Favin, *J. Lightwave Technol.* **12**, 917 (1994).
7. J. F. Zhang, M. Y. Yao, H. M. Zhang, Q. F. Xu, and Y. Z. Gao, *Opt. Commun.* **197**, 385 (2001).
8. X. M. Liu, C. Y. Li, R. H. Li, B. J. Yang, and X. G. Zhang, *Chin. J. Lasers* (in Chinese) **29**, 455 (2002).