

Experimental study on the system of Cl/Cl₂/He/HN₃/I₂

Liping Duo (多丽萍), Shukai Tang (唐书凯), Jian Li (李健),
Xiangde Min (闵祥德), Haijun Yu (于海军), and Bailing Yang (杨柏龄)

Short Wavelength Chemical Laser Laboratory, Dalian Institute of Chemical Physics,
Chinese Academy of Sciences, Dalian 116023

Received September 3, 2002

Using a microwave generator, chlorine diluted by helium was dissociated to chlorine atoms that subsequently reacted with hydrogen azide to produce the excited states of NCl(a¹Δ). Meanwhile, molecular iodine with carrier gas of helium reacted with atomic chlorine to produce atomic iodine which then was pumped to excited state of I(²P_{1/2}) by an energy transfer reaction from NCl(a¹Δ). In this paper, the changes of NCl(a¹Δ) and NCl(b¹Σ) emission intensity is presented when I₂/He is introduced into the stream of Cl/Cl₂/He/HN₃/NCl(a¹Δ)/NCl(b¹Σ). The dependences of atomic iodine I(²P_{1/2}) on flow rates of gases were also investigated. The optimum parameters for I(²P_{1/2}) production are given.

OCIS codes: 140.3320, 020.7010.

Being the shortest wavelength chemical laser and the only laser based on electronic transition, the chemical oxygen-iodine laser (COIL) is of great interest owing to its potential applications in both industrial and military fields^[1]. As the energy source of the laser, O₂(a¹Δ) is produced by the reaction of gaseous chlorine with liquid basic hydrogen peroxide (BHP) in the singlet oxygen generator (SOG), which is a main part of the COIL and occupies most of the COIL in size and weight, so power-volume or power-weight efficiency is limited by the gaseous-liquid reaction. Moreover, there are strong quenchers for excited atomic iodine, for example, water vapor and hydrogen peroxide, produced in SOG. Consequently, it is necessary to look for metastable particles instead of O₂(a¹Δ) to pump iodine atoms.

Bower and Yang reported the nearly resonant energy transfer from metastable NCl(a¹Δ) to atomic iodine in 1990^[2]. The concept of NCl(a¹Δ)/I as a newly possible laser system is becoming a hot point. Yang *et al.* achieved population inversion between I(²P_{1/2}) and I(²P_{3/2}) in 1992^[3], Henshaw and his group at the Air Force Research Laboratory measured the gain on the 1315 nm transition of atomic iodine in a subsonic flow of chemically generated NCl(a¹Δ) in 1999^[4] and subsequently showed an output power of 180 mW from a new energy transfer chemical iodine laser pumped by NCl(a¹Δ) at 1315 nm in 2000^[5].

The mechanism of the system for a chemical atomic iodine laser pumped by NCl(a¹Δ) is generally as follows: Production of NCl(a¹Δ)^[6]

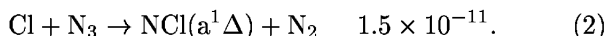

Production of atomic iodine^[7,8]

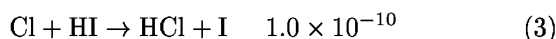

or

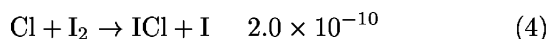

or

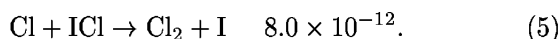

Production of excited atomic iodine^[9]

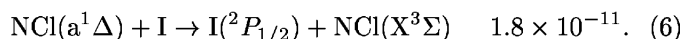

The above reactive rates are in units of cm³/(s·molecule). Lasing^[8]

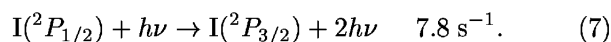

In this paper, by means of a microwave generator to dissociate chlorine to atoms directly and using I₂ as atomic iodine carrier, we studied parametric dependences of excited state of I(²P_{1/2}) in the system of Cl/Cl₂/He/HN₃/I₂ for the first time. The changes of NCl(a¹Δ) and NCl(b¹Σ) emission intensity is also presented upon admitting I₂/He into the stream of Cl/Cl₂/He/HN₃/NCl(a¹Δ)/NCl(b¹Σ). The optimum parameters for I(²P_{1/2}) production are given finally.

The structure of the setup is shown in Fig. 1. The setup mainly consists of the microwave generator of 1000 W, the gas supply system, the detection system, and the pumping system. The mixture of chlorine and helium flowed through the wave-guide to produce chlorine atoms, which then mixed and reacted with the mixture of hydrogen azide and helium at the ratio of 1 : 10 which was admitted into the reaction duct through 4 rows of 36 holes on the upper and lower wall. Before the injectors of HN₃/He, there are the injectors of I₂/He. Emissions from NCl(a¹Δ) and NCl(b¹Σ) were collected by an OMA4 and 1315-nm emission from excited iodine was detected by a NIR detector with a filter and then processed by a computer.

Upon I₂/He injecting into Cl/Cl₂/He/HN₃/NCl(a¹Δ)/NCl(b¹Σ), the changes of NCl(a¹Δ) and NCl(b¹Σ) emission intensity are remarkable as shown in Fig. 2.

NCl(a¹Δ) emission intensity has a decrease promptly while NCl(b¹Σ) emission intensity increases sharply. This is exactly due to the reaction (6) to consume NCl(a¹Δ). There is a sharp increase of NCl(b¹Σ) emission owing to the reaction^[10]



The intensity of $I(^2P_{1/2})$ emission along the reaction duct was investigated. The maximum is at the beginning of the reaction duct and 1315 nm emission intensity decreases along the flow channel. In the following parametric study of $I(^2P_{1/2})$ emission, the detector was located at the beginning of the reaction duct.

The dependence of intensity of $I(^2P_{1/2})$ emission on the flow rate of He was studied. The intensity of $I(^2P_{1/2})$ emission has a maximum at lower flow rates of helium and then decreases with increasing flow rates of helium.

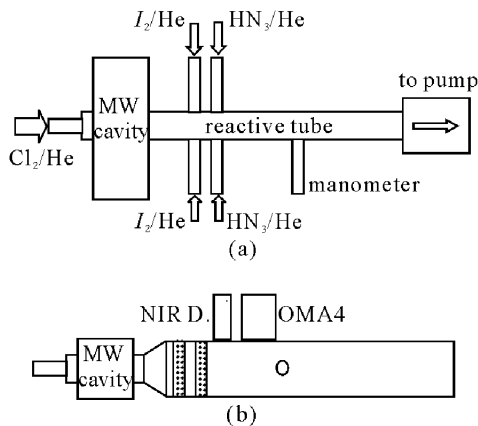

Fig. 1. The experimental setup. (a) Side view; (b) Planform.

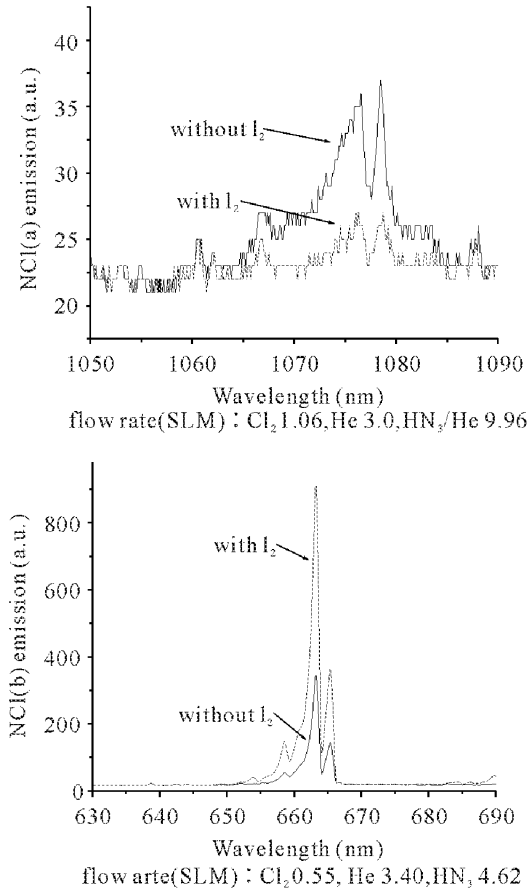

Fig. 2. Spectra of $NCl(a^1\Delta)$ and $NCl(b^1\Sigma)$ with and without I_2 .

But the 1315 nm emission signal can not be detected in the case of without the diluent gas of helium. However, it is necessary to admit a little helium to sustain the gas discharge. The optimum flow rates of helium are in the range of 1 – 3 SLM (Standard Liter per Minute).

The intensity of $I(^2P_{1/2})$ emission versus the flow rate of Cl_2 is shown in Fig. 3 in which the maximum intensity of $I(^2P_{1/2})$ emission was at the flow rate of 1.8 – 2.2 SLM of chlorine.

It is easily understood that more or less chlorine can cause a decrease in the production of $I(^2P_{1/2})$ as discussed in Ref. [11]. It is worth notice that the chlorine flow rates of 1.8 – 2.2 SLM for the maximum of $I(^2P_{1/2})$ emission intensity are more than that of 1.2 – 1.5 SLM for the maximum of $NCl(a^1\Delta)$ and $NCl(b^1\Sigma)$ emissions due to the consumption of atomic chlorine in reactions (4) and (5) in the system of $Cl/Cl_2/He/HN_3/I_2$.

The intensity of $I(^2P_{1/2})$ emission versus the flow rate of HN_3/He at different chlorine flow rates is shown in Fig. 4 in which it can be seen that the signal of $I(^2P_{1/2})$ emission increases with the flow rates of HN_3/He , but can not be obtained the maximum position from this profile.

The intensity of $I(^2P_{1/2})$ emission versus the flow rate of I_2 is shown in Fig. 5 in which it can be seen that the maximum of $I(^2P_{1/2})$ is produced at the flow rates of

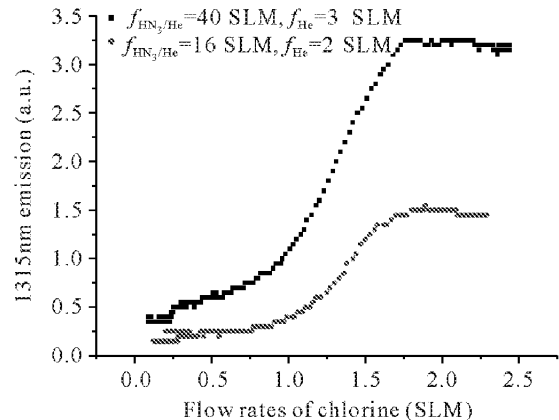

Fig. 3. The intensity of $I(^2P_{1/2})$ emission versus the flow rate of Cl_2 .

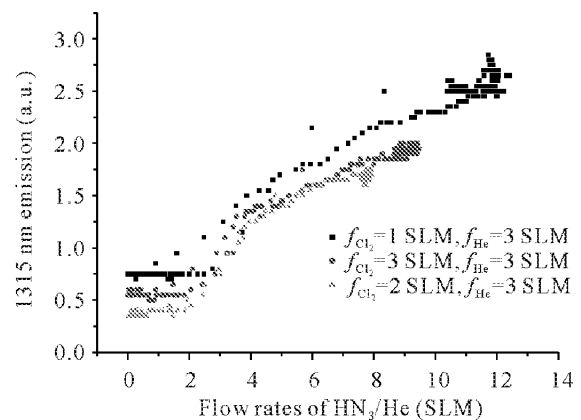

Fig. 4. The dependence of density of $I(^2P_{1/2})$ on the flow rate of HN_3/He .

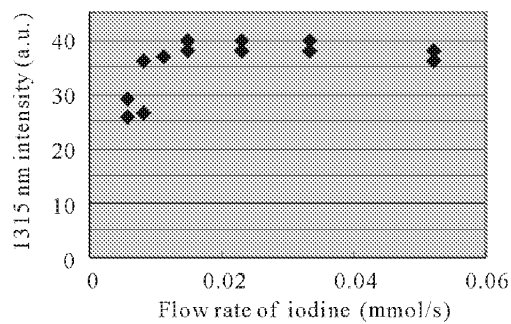

Fig. 5. The intensity of $I(^2P_{1/2})$ emission versus the flow rate of I_2 .

Table 1. The Optimum Operating Parameters for the Present Setup

HN_3/He Flow Rate (SLM)	40 – 60
Cl_2 Flow Rate (SLM)	1.8 – 2.2
He Flow Rate (SLM)	1 – 3
I_2/He Flow Rate (SLM)	25 – 65
Pressure (Torr)	~ 1.5
Reaction Duct (mm^2)	20×50
Discharge Current (mA)	280
Linear Velocity (m/s)	~ 200

0.02 mmol/s of I_2 and has a flat region in the range of 0.02–0.05 mmol/s. This indicates that the production of $I(^2P_{1/2})$ is insensitive with the input flow rate of iodine in the specific range.

The optimum operating parameters for the present setup are listed in Table 1.

Through the parametric study of $I(^2P_{1/2})$ emission, it

can be seen that the optimum parameters for the production of $I(^2P_{1/2})$ were the chlorine flow rates in the range of 1.8 – 2.2 SLM, HN_3/He (1:10) about 40 – 60 SLM, helium in the range of 1 – 3 SLM, I_2/He (1:1000) in the range of 25 – 65 SLM and the pressure of the reaction tube at about 1.5 Torr in our present experimental conditions.

The authors also would like to thank the support of the National Natural Science Foundation of China (Grant No. 10174080) and the Hi-Tech 863 R&D project. L. Duo's e-mail address is dlp@dicp.ac.cn.

References

1. Q. Zhuang, F. T. Sang, and D. Zhou, *Short Wavelength Chemical Laser*, (in Chinese) (1st ed.) (The Publishing House of the National Defense and Industry, Beijing, 1997) p.310.
2. T. T. Yang and R. D. Bower, Proc. SPIE **1225**, 430 (1990).
3. T. Yang and V. T. Gylys, Opt. Lett. **24**, 1803 (1992).
4. T. L. Henshaw, T. J. Madden, J. M. Herbelin, G. C. Manke II, B. T. Anderson, R. F. Tate, and G. D. Hager, Proc. SPIE **3612**, 147 (1999).
5. T. L. Henshaw, G. C. Manke II, T. J. Madden, M. R. Berman, and G. D. Hager, Chem. Phys. Lett. **325**, 537 (2000).
6. G. C. Manke II and D. W. Setser, J. Phys. Chem. A **102**, 7257 (1998).
7. G. C. Manke II, T. L. Henshaw, and T. J. Madden, Proc. SPIE **3931**, A-12 (2000).
8. G. P. Perram and G. D. Hager, AD-A208643, (1988).
9. T. L. Henshaw, S. D. Herrera, and L. A. Schlie, J. Phys. Chem. A **102**, 6239 (1998).
10. T. T. Yang, Proc. SPIE **2119**, 122 (1994).
11. L. P. Duo, S. K. Tang, J. Li, X. D. Min, F. T. Sang, and B. L. Yang, J. Phys. Chem. A **106**, 743 (2002).